

**TOPIC 7:**  
**COMPUTER**  
**COMMUNICATION**

**Unit One: Introduction to Computer  
Communication**

# Unit Objectives

To be able to know the:

- Definition of terminologies associated with computer communication
- Importance of computer communication
- Transmission media types.
- Wireless Broadcast
- Data Transmission
- Networking hardware
- Communications software
- Network topologies

# Definition of terminologies

- **Computer Communication**

**Computer communication is the transmission of data and information over a channel between two computers.**

- **Communications between computers can be as simple as cabling two computers to the same printer.**

# Computer Communication (Illustration)

- Computer Communication

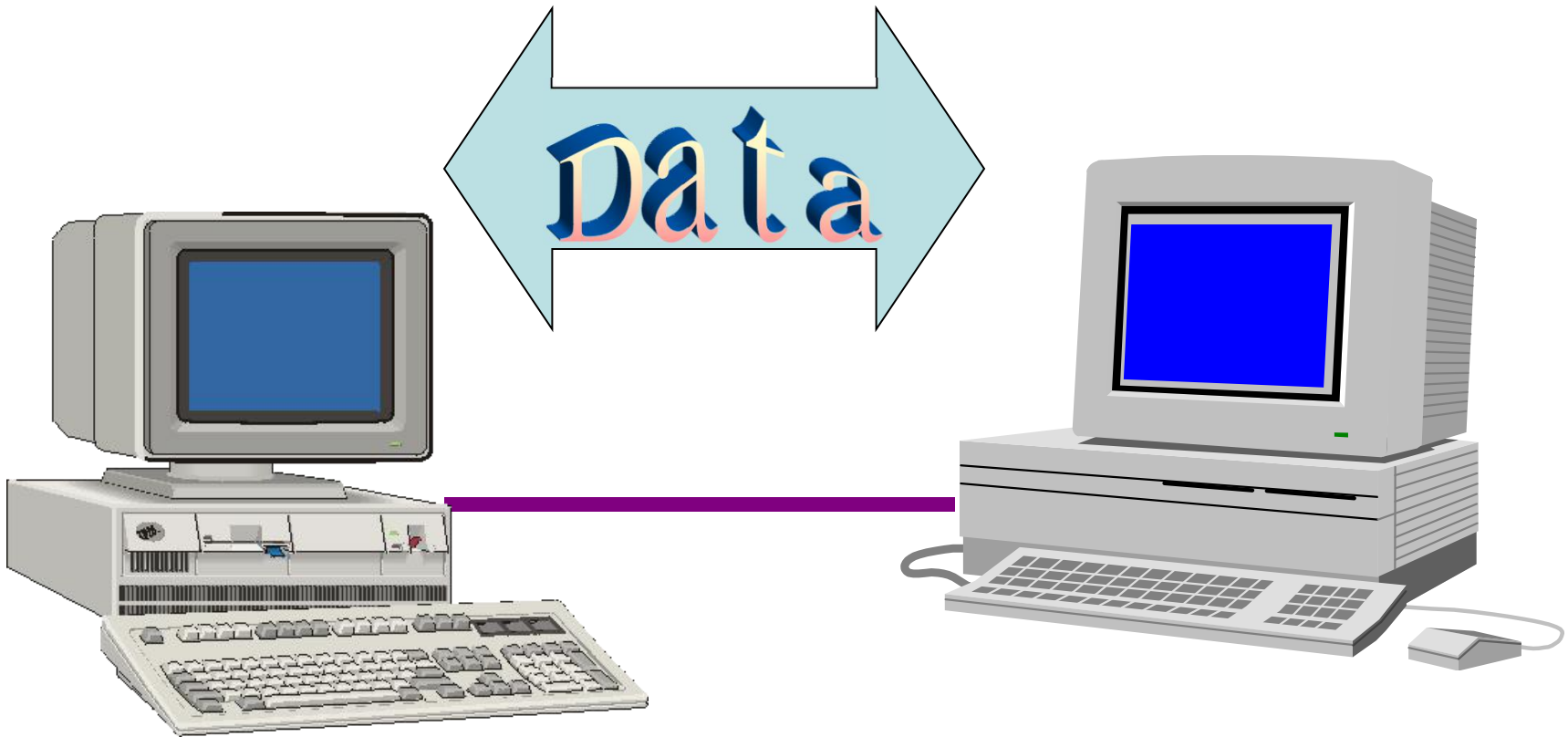

# Definition of terminologies

- **Computer Network**

- **A computer Network is a collection of two or more computers and devices connected by channels so that they can communicate with each other and share resources:**

- **Examples of resources**

- **data, a single internet connection,**
- **software,**
- **peripheral devices, processing power.**

# Definition of terminologies

## ■ Encoding

This is the process through which Information (e.g. data, text, voice or video) from the sending device is converted into signals which the

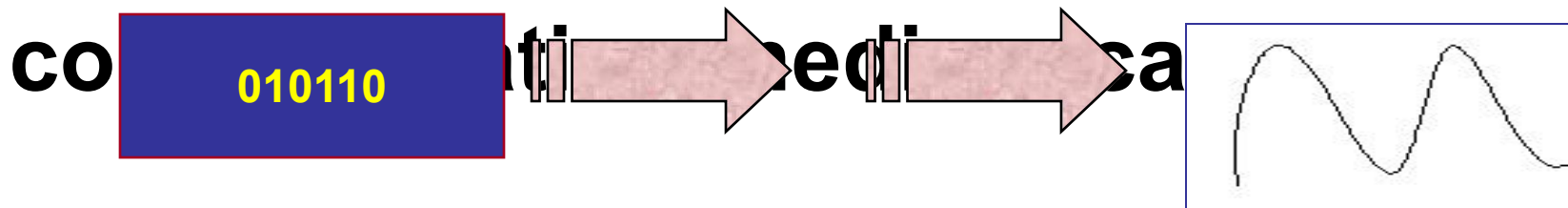

**Sending device  
send digital signal**

**Receiving device  
receive analog signal**

# Definition of terminologies

- **Transmission**

This is the process through which the signals are broad cast/ sent out through the medium to the receiving device.

- **Decoding**

- This is the process through which the signals are converted back into the information in its original form in the receiving device.

# Definition of terminologies

- **Telecommunication** refers to transmission of data and information over a long-distance, eg television
- **Teleprocessing:** This refers to access and modification of computer files located elsewhere.
- **Downloading:** To Download is to transfer a file to your computer from another.
- **Uploading** means to transfer a file from your computer to another.
- **Throughput** refers to the rate of how much data is moved during a certain amount of time.
- The amount of signals that can travel over a communications channel sometimes is called the **Bandwidth**. The higher the bandwidth, the more data and information the channel can transmit.



# Definition of terminologies

## ■ Data Encryption

- This is Process of converting data into coded form (cypher text) to prevent it from being read or understood by unauthorized people.
- Encrypted data is difficult to decode without a secret key

## ■ Communications Software

- This refers to a set of instructions (software) needed by a computer before it

# Importance of computer communication

- It allows sharing of hardware like printers.
- It allows sharing of software between two or more computers, hence reducing on cost.
- It allows sharing and transfer of data and information stored on other computers on the network.
- Facilitate communications between

# Importance of computer communication

- Computer communication has security & tight control measures over data access.
- It enables online learning and collaborative research.
- It allows access to common databases for example in banks.
- Has enabled improved travel service through e-bookings and e-reservation.
- Provides for online employment e.g. telecommuting.

# Limitations of computer communication

- **Data theft.** If a computer is a standalone, physical access becomes necessary for any kind of data theft. However, if a computer is on a network, a computer hacker can get illegal access.
- **Rapid Spread of Computer Viruses:** If any computer system in a network gets infected by computer virus, there is a possible threat of other systems getting infected.
- **Expensive Set Up:** The initial set up cost of a computer network can be high depending on the number of computers to be connected.
- **Dependency on the Main File Server:** In case the main File Server of a computer network breaks down, the system becomes useless.

# Limitations of computer communication

- **Exposure to External Exploits.** Someone on a different computer can send data to the computer in such a way as to attack it - make it lock up or crash, make it slow down, or even take control of it.
- **Automatic Downloads.** If a computer is connected to a network, it's easier to download and install software from the network onto the computer without any human intervention. If the new software hasn't been tested, it could cause unpredictable behavior.
- **Computer Networks can Fail.** Computer networks can be so powerful and useful that it is very vital for them to be used. All of the computers in an office building might become completely useless if a single network component fails.

# Transmission media (Channels)

- **Transmission media** refers to the physical materials that are used to transmit data between computers.
- For communications between computers that are linked by cable, there are three choices:
  - Twisted wire,
  - Coaxial cable,

# Twisted wire

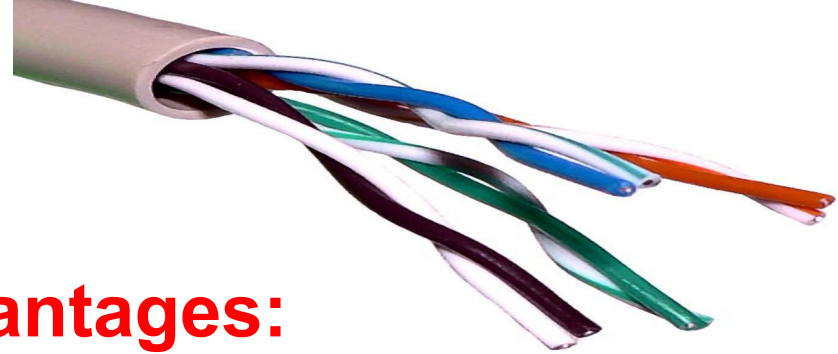

- Twisted pair cable comes in two varieties: Shielded and Unshielded Twisted Pair (UTP).
- UTP is the most

## Advantages:

- It is of low cost
- small in size
- easy to install
- It is the most popular and generally the best for schools.

## Disadvantage:

- Subject to interference
- limited distance, usually less than 100 meters

# Coaxial cable

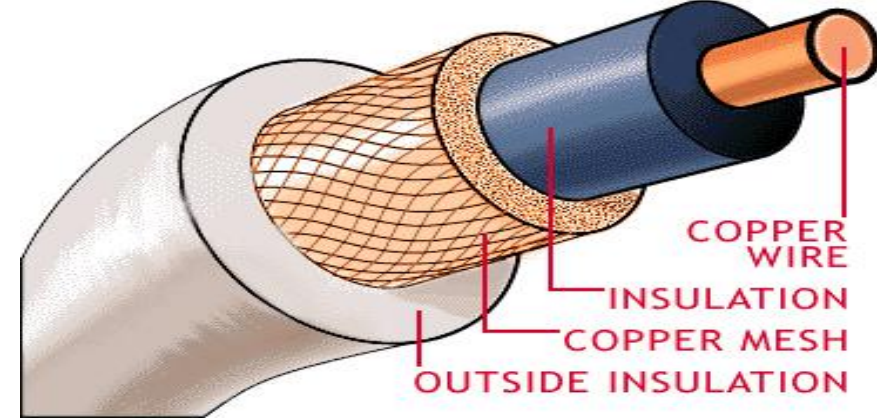

## Advantages

- Coaxial cable is insulated more heavily than twisted-pair cable. So it is highly resistant to signal interference.
- Used for longer distances (300 – 600 meters)
- Transmits faster than UTP

## Disadvantages

- Heavy & bulky
- Needs booster over longer distances

- Coaxial cable consists of a single copper wire surrounded by at least three layers:
- An insulating material
- A woven or braided metal
- A plastic outer coating.
- Cable TV wiring often uses coaxial cable because it can be cabled over longer



# Fiber Optic Cable

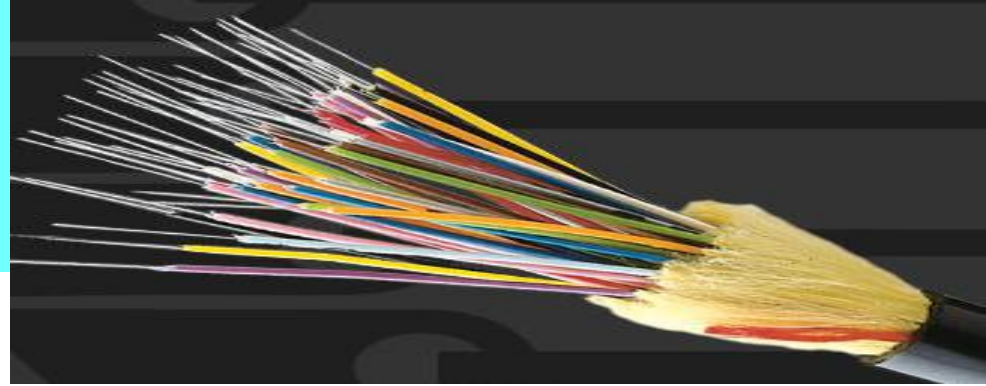

- Each strand, called an optical fiber, is as thin as a human hair.
- Each optical fiber is surrounded by an insulating glass cladding and a protective coating.
- Fiber-optic cables are used by many local and long-distance telephone companies, cable TV, and in high-traffic networks or as the main cable in a network.

## Advantages:

- Carry significantly more signals than other cables.
- Faster data transmission.
- Less vulnerable to electrical noise from other devices
- Better security for signals during transmission.
- Smaller size, and much thinner and lighter than other cables.

## Disadvantages:

- Expensive as compared to other media
- Harder to install and modify.

# Wireless Broadcast



- ***Wireless telecommunications*** technologies transport digital communications without cables between communications devices.
- **Wireless transmission media** used in communications include broadcast radio, cellular radio, microwaves, communications satellites, and infrared & bluetooth.
- **Wireless transmission** is more convenient than installing cables but it has **Slower data transfer** than hard-wired methods and it is

# Microwave

- **Microwaves are high-frequency radio waves that are sent through the atmosphere and space to deliver telecommunications services, including TV distribution. It is dependent on line of sight.**
- **Advantage:**
  - Speed of light
  - Microwave signals can carry thousands of channels at the same time
- **Disadvantage:**
  - Line-of-sight only-  
(there is need for radio transmitters in networks using air interface (radio waves) to be positioned free of obstacles)

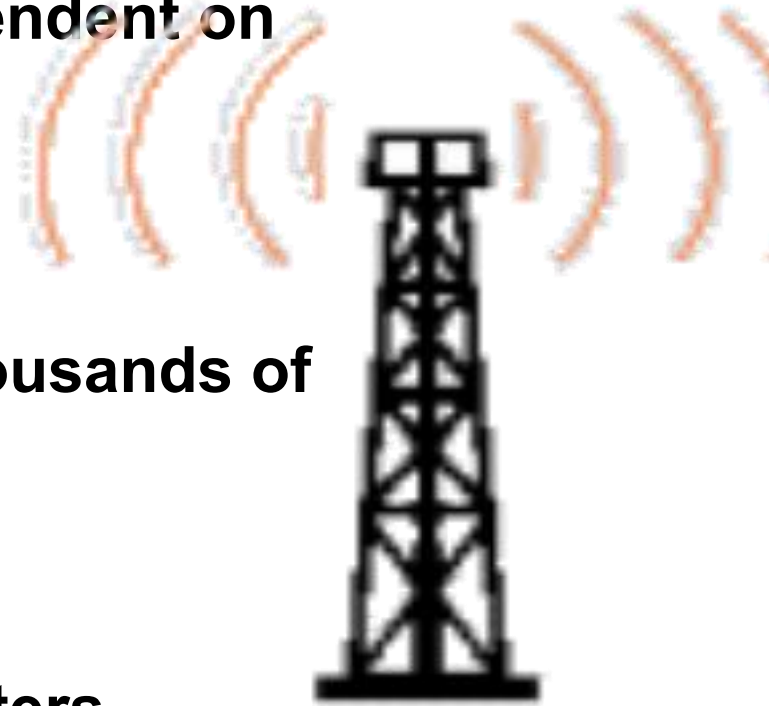

# Satellite

- *A satellite is basically a microwave station placed in outer space. The satellite receives a signal from the earth, amplifies it, and then rebroadcasts it at a different frequency to any number of earth-based stations.*
- **Advantage:** Always in sight
- **Disadvantage:** Expensive uplink and downlink

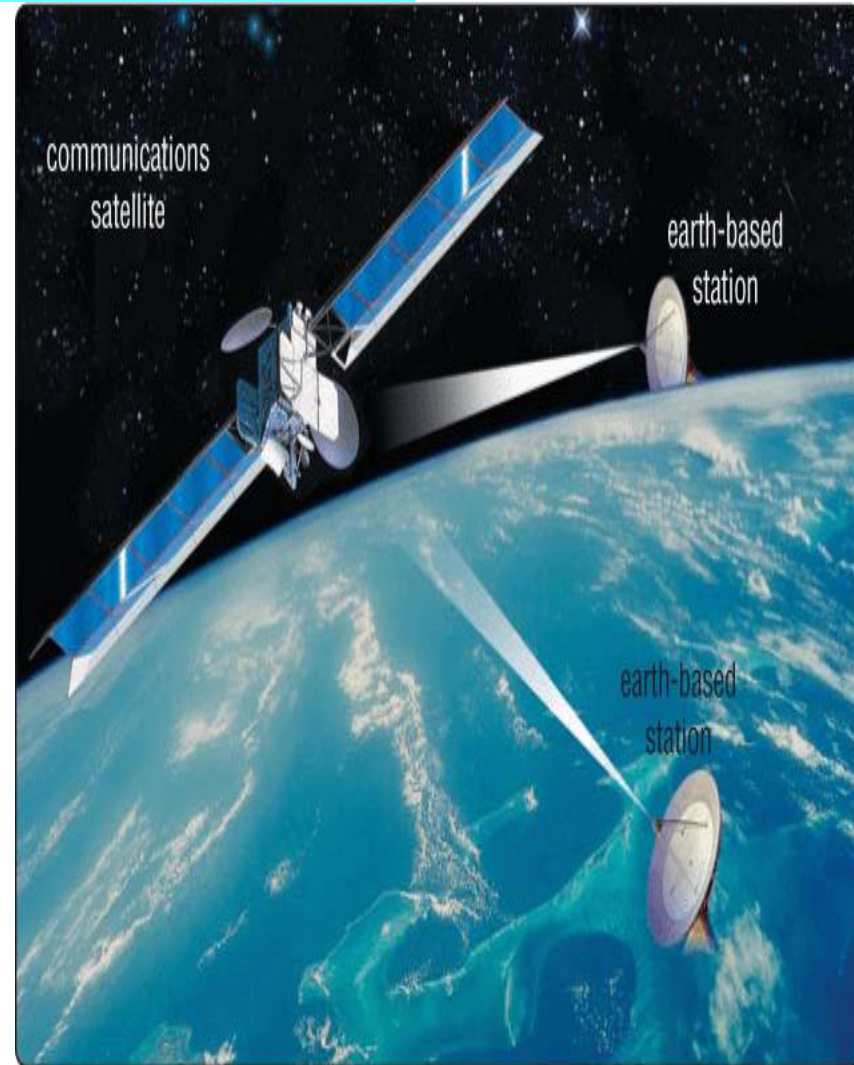

# Infrared and Bluetooth

- IrDA (Infrared Data Association) ports transmit data via infrared light waves. As long as the devices are within a few feet and nothing obstructs the path of the
- infrared light wave, data can be transferred without the use of cables.
- Bluetooth port is an alternative to IrDA. Bluetooth technology uses radio waves to transmit data between two devices.
- Many computers, peripherals, smart phones, PDAs, cars, and other consumer electronics are Bluetooth-enabled, which means they contain a small chip that allow them to communicate with other Bluetooth-enabled computers and devices.

# DATA

## TRANSMISSION

- Telecommunications involves the transmission of data, information, and instructions among computers.
- Any transmissions sent during these communications can be categorized by a number of characteristics including the signal type, transmission mode, transmission direction, and transmission rate.
- **Signal Type:** Recall that computers produce

# Analog Signals

- An analog signal uses variations which are represented by a continuous waveform to convey information.
- It is particularly useful for wave data like sound waves.
- Analog signals are what normal phone line and sound speakers use.

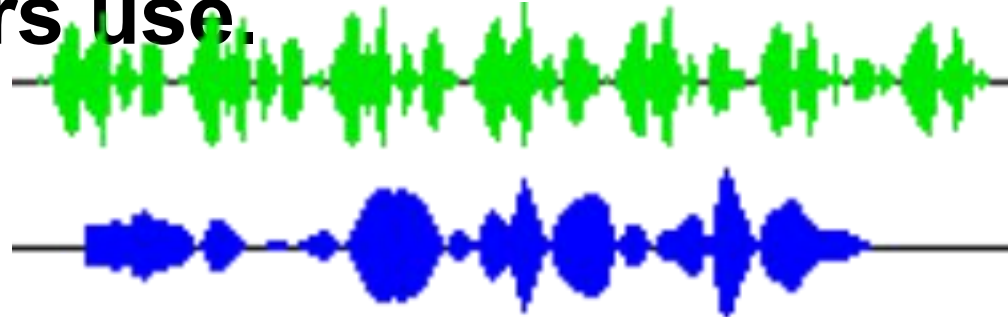
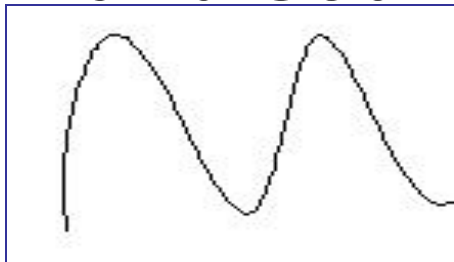

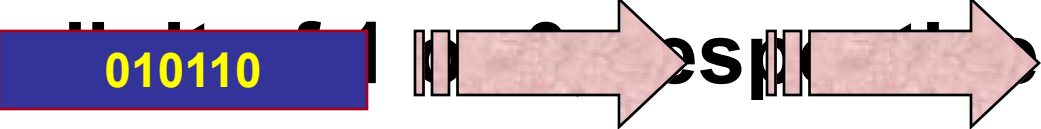

# Digital Signals

- A digital signal is a series of discrete (discontinuous) bits which are simply the presence or absence of an electric pulse. The state of being on or off represents the binary **010110** respectively.
- 

- Advantages of digital signals include:
  - Digital signals can be copied exactly without any loss of quality
  - Digital signals can be further processed



# Transmission Modes

- When two devices exchange data, the data flows between the devices as a continuous stream of bits.
- There are two basic transmission techniques for separating the groups of

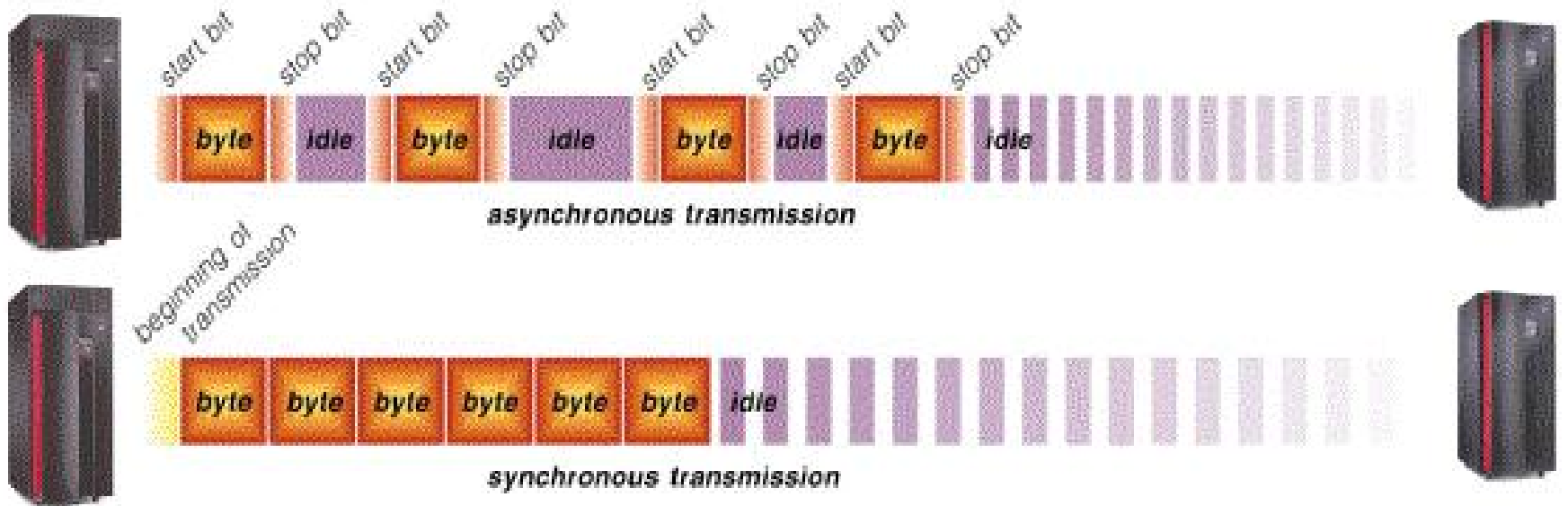

# ***Asynchronous transmission***

- ***Asynchronous transmission transmits one byte at a time over a line at random intervals.***
- ***Each byte is framed by controls—a start bit for marking the beginning of the byte, a stop bit for marking the end of the byte, and a parity bit for error checking.***
- ***Asynchronous transmission is relatively slow and used for low-speed transmission.***

# ***Synchronous transmission***

- ***Synchronous transmission transmits groups of bytes simultaneously at regular intervals.***
- ***The beginning and ending of a block of bytes is determined by the timing of the sending device and receiving devices.***
- ***Although synchronous transmission requires more complicated and expensive communications devices, it provides much higher speeds and greater accuracy than***

# Transmission Direction

- **The direction in which data flows along transmission media is characterized as**
  - **simplex,**
  - **half-duplex,**
  - **full-duplex or**
  - **multiplex**

# Simplex transmission

- *Simplex transmission sends data in one direction only.*
- *Simplex transmission is used only when the sending device does not require a response from the receiving device. One example of simplex transmission is television*



server

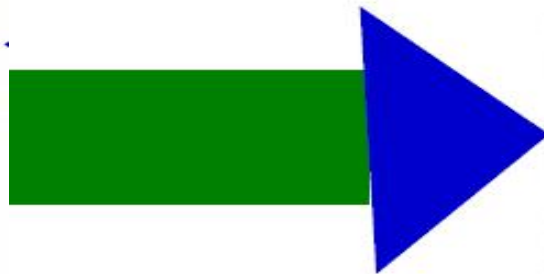

# Half-duplex transmission

- *Half-duplex transmission allows data transmission in either direction, but only one way at a time.*
- *Many fax machines, police radio calls, credit card verification systems and*

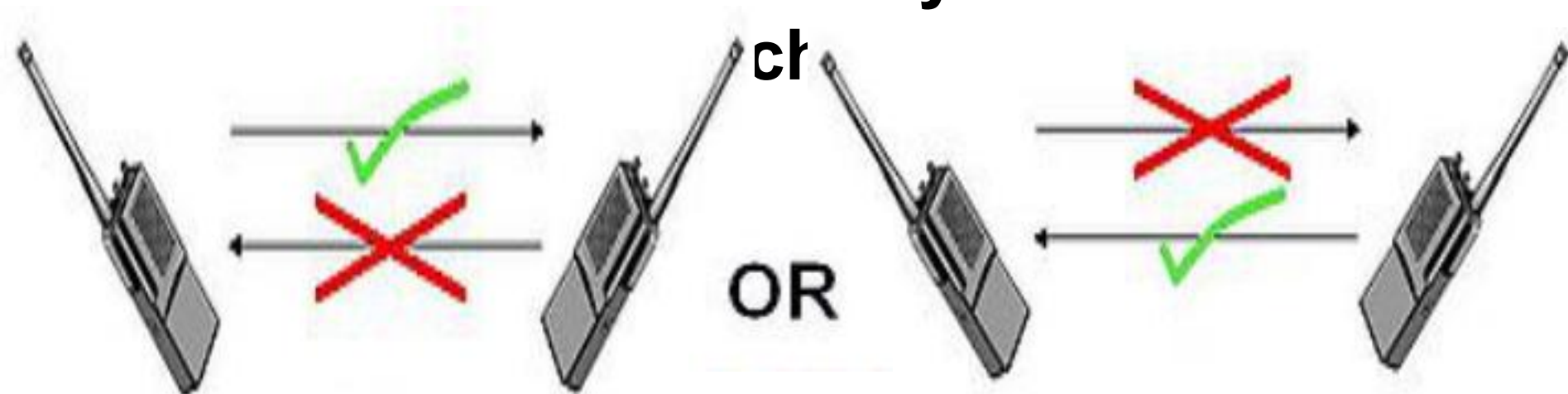

# Full-duplex transmission

- In *full-duplex transmission*, data can flow in both directions at the same time. A regular telephone line, for example, supports full-duplex transmission,

**Full-duplex transmission**  
both directions simultaneously



server



# Multiplex transmission

- In *multiplex transmission*, several different types of signals can be carried at once through the same line. E.g. During Video

**Multiplex transmission**  
different type of signals simultaneously



server







# Networking hardware

- Networking hardware includes all computers, peripherals and Communications devices that enable two or more computers to exchange items such as data, instructions, and information with each other.
- Examples include: a server computer, clients/work stations, network interface card, modems, Hub/Switch,

# 1. SERVER

- A server is the host or central computer that manages the resources on a network.
- A server provides a centralized storage area for programs, data, and information.
- A dedicated server is a server that performs a specific task. Examples of dedicated Servers include: file server, print server, database server, and a network server

# Roles of Dedicated Servers

- A file server stores and manages files on a network
- A print server manages printers and print jobs.
- A database server stores and provides access to a database
- A network server (e.g., a DNS) manages network traffic.

# Requirements of a server computer

- It needs a computer with very high processing speed
- It needs large amounts of RAM
- It needs a very big storage capacity
- It needs a very fast Network interface card
- It needs network operating system such as Novell Netware, Windows NT Server or Apple Share

# 2. NETWORK INTERFACE CARD

- A network card, also called network interface card (NIC), is a device that enables the computer or device that does not have built-in networking capability to access a network.
- Examples include adapter card, PC Card, USB network adapter,

Network card for desktop computer



Wireless network card



USB network adapter



# 3 MODEMS (signal converters)

- The modem, is a device which Modulates a digital signal from computers into an analog one to send data out over the phone line. Then for an incoming signal it Demodulates, the analog signal into a digital one.

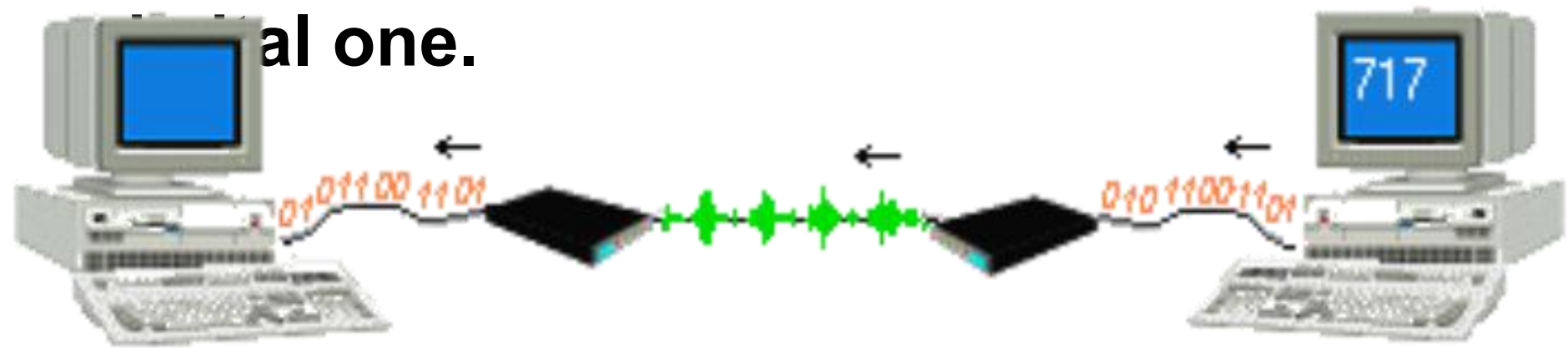

# 4. HUBS and SWITCHES

- A **hub**, (also called a multi-station access unit (MAU)) is a device that provides a central point for cables in a network.
- Unlike the hubs, a **switch** does not broadcast the data to all the computers, it sends the data packets only to the





# 5. REPEATER

- A repeater is a device that accepts a signal from a transmission medium, amplifies it, and retransmits it over the medium.
- As a signal travels over a long distance, it undergoes a reduction in strength, an occurrence called attenuation.

# 6. A ROUTER

- A Router connects multiple networks and routes communications traffic to the appropriate network using the fastest available path.
- A router allows multiple computers to share a single high-speed Internet connection such as



# 7. NETWORK BRIDGE

- *A bridge connects two pieces of land together offering a path from one to another.*
- A network bridge is device that connects two networks
- A bridge knows all of the addresses on each side of the bridge and can send

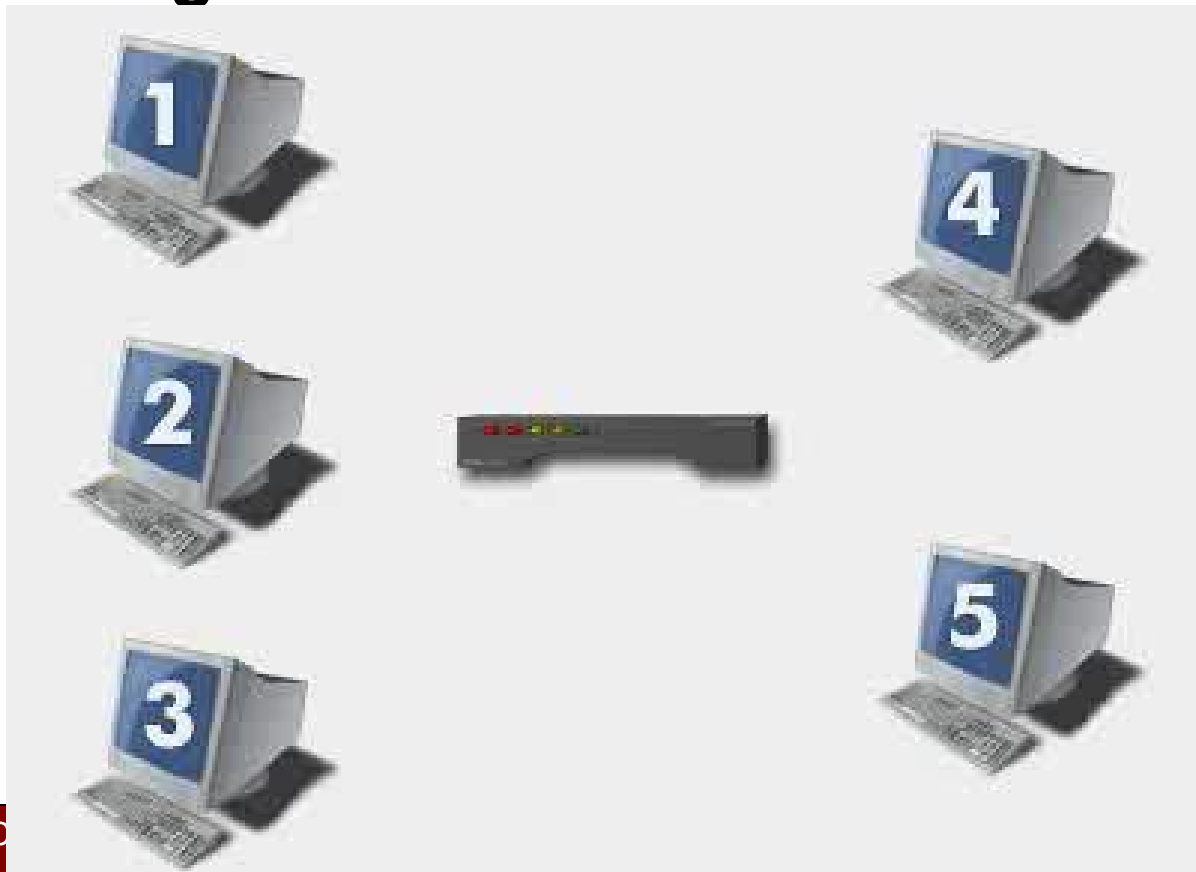

# 8. MULTIPLEXER

- ***A multiplexer is a device that combines two or more input signals from various devices into a single stream of data and then transmits it over a single transmission medium.***
- **By combining the separate data streams into one, a multiplexer increases the efficiency of communications and reduces the need for using multiple separate transmission media.**

# COMMUNICATIONS SOFTWARE

- The principal functions of communications software are network control, access control, transmission control, error detection/correction, and network security.
- *Communications software consists of programs that :*
  1. (1) *help* users establish a connection to another computer or network;
  2. (2) manage the transmission of data, instructions, and information;
  3. (3) provide an interface for users to communicate with one another.

# Networking Operating System

- A network operating system (NOS) is the system software that organizes and coordinates the activities on a network. The principal functions of NOS include network control, access control, transmission control, error detection/correction, and network security.
- System maintenance tasks such as backup
- File management tasks
- Examples of NOSs include:
  - Novell NetWare
  - Microsoft Windows server 2003 and 2008.
  - AppleShare
  - Unix /NFS
  - Sun Solaris

# Network Protocols

- This refers to a set of rules and procedures governing transmission between components
- The principal functions of protocol in a network include:
  - identifying each device in the communication path;
  - securing the attention of the other device;
  - verifying correct receipt of the transmitted message;
  - determining that a message requires retransmission if it is incomplete or has errors;
  - performing recovery when errors occur.

# Packets and Packet Switching

- When a computer sends data over the Internet, the data is divided into small pieces called packets.
- Each packet contains the data, as well as the recipient (destination), the origin (sender), and the sequence information used to reassemble the data at the destination.
- Each packet travels along the fastest individual available path to the recipient's computer via communications devices called routers.
- This technique of breaking a message into



# Common protocols

- Simple Mail Transfer Protocol (SMTP) - an internet protocol for transferring of e-mails.
- **File Transfer Protocol (FTP):** It allows files containing text, programs, graphics, numerical data, and so on to be downloaded off or uploaded onto a network.
- Internet Protocol (IP) - does the packet forwarding and routing.
- Transmission Control Protocol/Internet Protocol (TCP/IP) is a network standard that defines how messages (data) are routed from one end of a network to the other, ensuring the data arrives

# Common protocols

- **Hypertext Transfer Protocol (HTTP):** It allows Web browsers and servers to send and receive Web pages.
- **Simple Network Management Protocol (SNMP):** It allows the management of networked nodes to be managed from a single point.
- **Telnet Protocol:** It provides terminal emulation that allows a personal computer or workstation to act as a terminal, or access device, for a server.
- **Sequential Packet Exchange (IPX/SPX)** - works with the Novell's internet work' packet / sequential exchange; responsible for delivery of sequential

# Comminucations application software.

- These are computer software programs that help to accomplish specific tasks related to telecommunications.
- A variety of examples of application software for communications
  - e-mail,
  - FTP,
  - Web browsers,
  - newsgroup/message boards,
  - chat rooms,
  - instant messaging,
  - video conferencing, and
  - VoIP.

# NETWORK TOPOLOGIES

- A network topology is a description of the possible physical connections within a network.
- In other words, a topology is the physical arrangement of the devices in a communications network.
- Three commonly used network topologies are bus, ring, and star. However, Most computer networks are hybrids— combinations of these topologies.



# Bus topology

- A bus or linear network topology consists of a single central cable that connects all computers and devices together.
- The physical cable that connects the computers and other devices is known as

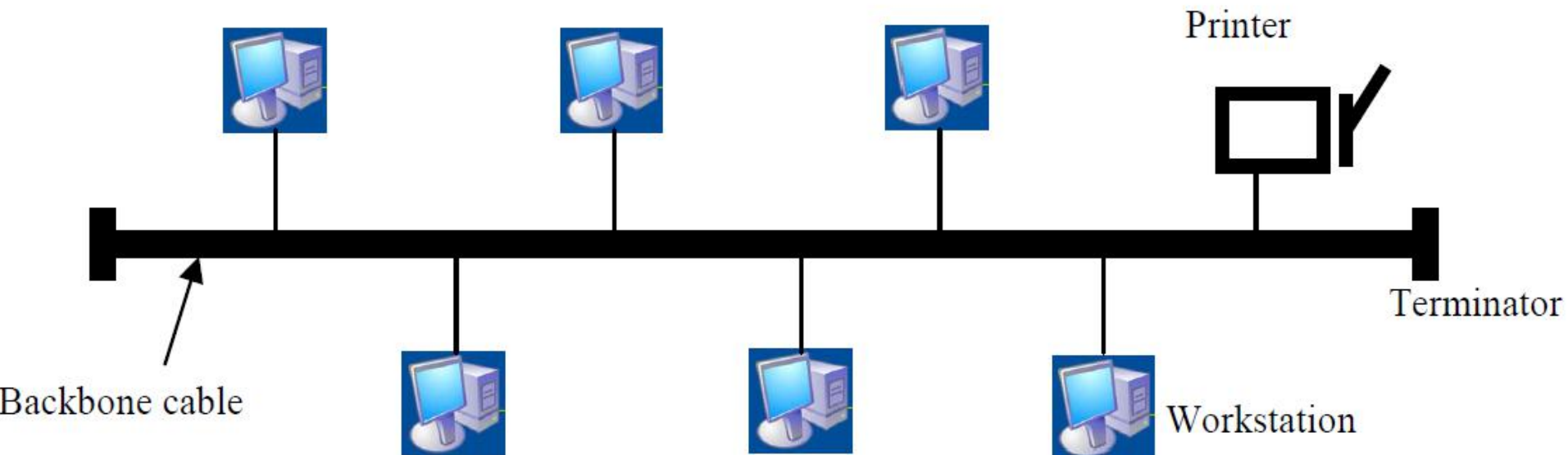

# Merits of BUS Topology

- Easy to implement and extend (quick setup)
- Cheaper than other topologies.
- Computers and devices can be attached and detached at any point on the bus without disturbing the rest of the network.
- Failure of one device usually does not affect the rest of the bus network.
- Data, instructions, and information in a bus network can be transmitted in both directions.
- Cable faults are easily identified.
- Weight reduction due to less wires

# Demerits of BUS Topology

- If there is a problem with the cable, the entire network goes down.
- There is no central host computer to control the network.
- Only one device can transfer items at a time.
- If many computers are attached, the amount of data flowing along the cable increases, data collisions occur and the network slows down.
- Limited cable length and number of stations.
- Performance degrades as additional computers are added or on heavy traffic.(shared bandwidth)

# Ring Topology

- Ring network consists of a cable forming a closed ring, or loop, with all the computers and devices in a network
- A ring network links all nodes together in a circular chain.
- The node examines any data that passes by to see if it is the addressee; if not, the data is passed on to the next node in the ring

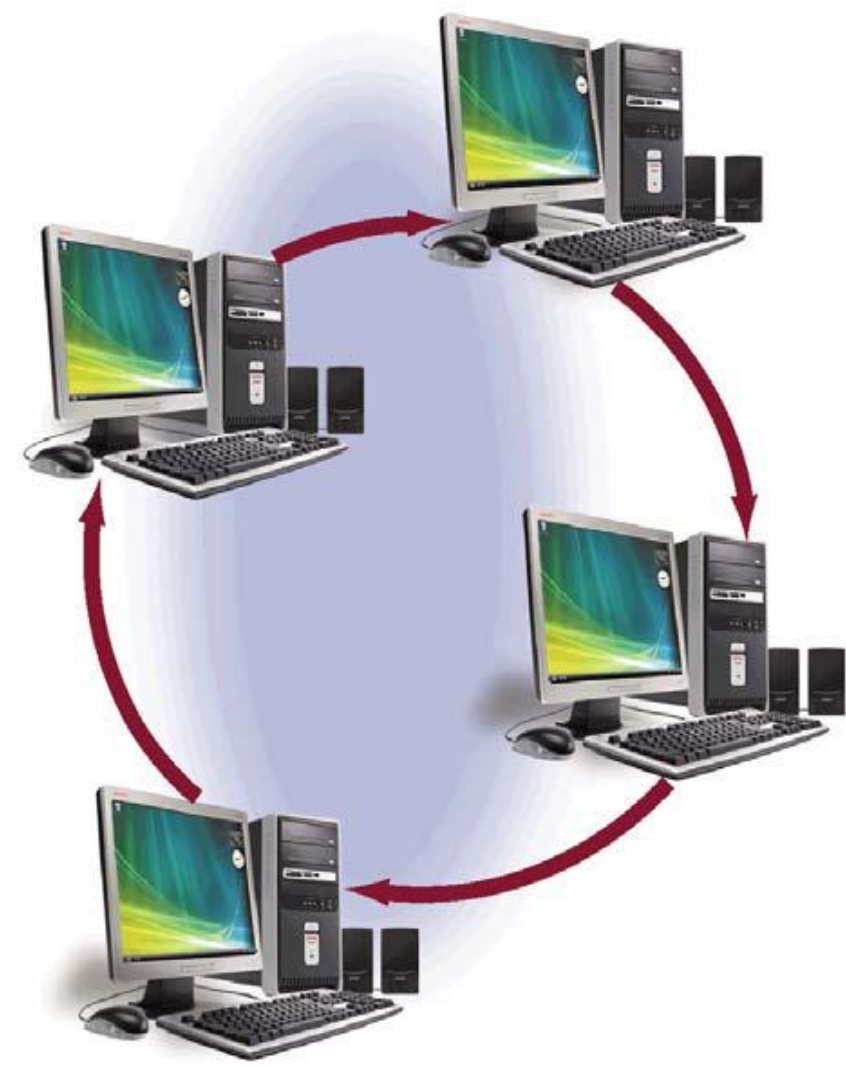



# Advantages of Ring Topology

- Ring topology Can cover a larger distance as compared to a bus network and is commonly used in wide area networks (WAN)
- No collisions occur because data takes one direction only
- Very orderly network where every device has access to the token and the opportunity to transmit
- The speed of data transmission is faster than in a bus topology

# Demerits

## of a Ring Topology

- Ring Topology Network is More difficult to establish.
- If the cable fails, the whole network goes down.
- Data messages travel in only one direction from device to device around the entire ring
- If a node on a ring network fails, all nodes after the failed nodes cannot function.
- There is no central host computer to control the network.



# Star Topology

- On a star network, all of the computers and devices (nodes) on the network connect to a central hub or switch.
- All data that is transferred from

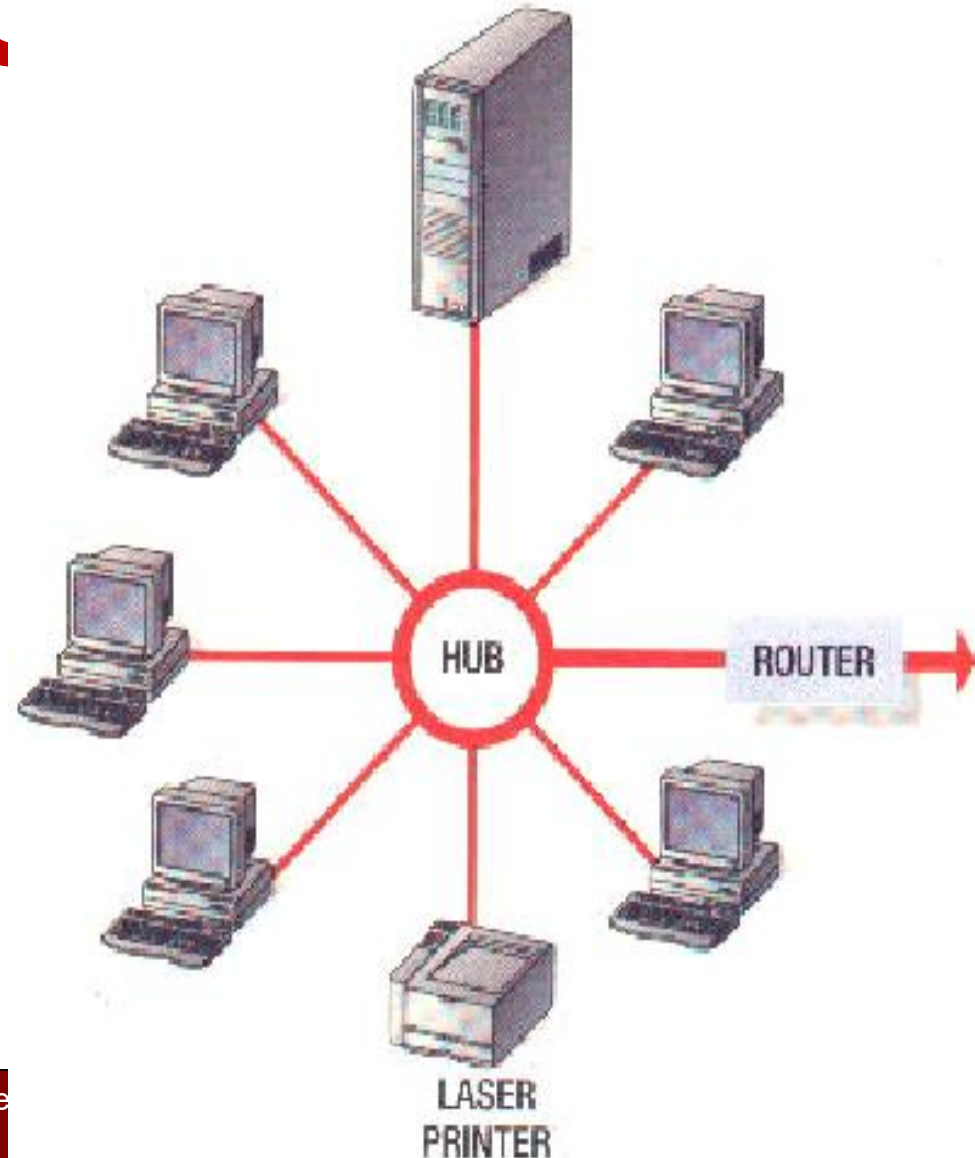

# Merits of a Star Topology

- **Easy to install and maintain.**
- **Better performance: The star topology prevents the passing of data packets through an excessive number of nodes.**
- **Computers and devices can be added to or removed from the network with little or no disruption to the network.**
- **Reliable because each device connects directly to the hub, if one device fails, only that device is affected.**

# Demerits of a Star Topology

- If the hub fails, the entire network fails
- Lots of cable required so that the installation cost is expensive.
- Network size is limited by the number of connections that can be made to the hub.
- Performance for the entire network depends on the capabilities of the hub.
- Set up of the system can be very complex.

# Mesh Topology

- This is the type of network topology in which each of the nodes of the network is connected to each of the other nodes in the network.
- Fully connected Mesh topology makes it possible for data to be

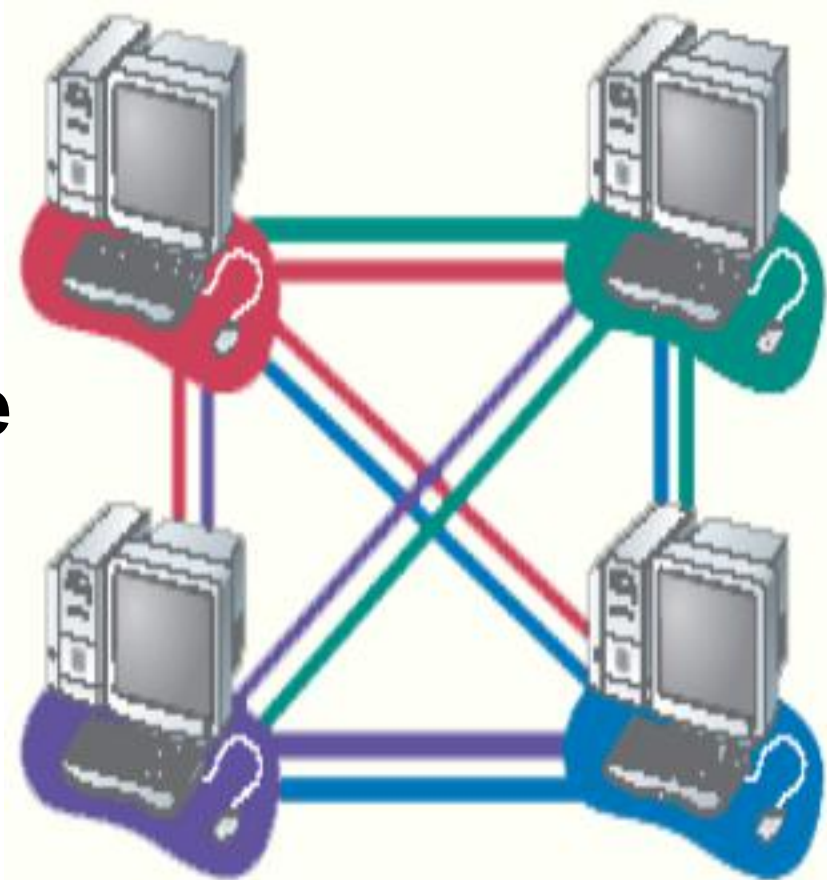

# Merits of Mesh Topology

- **Data will always be delivered.**
- **All of the data that is transmitted between nodes in the network takes the shortest path between nodes.**
- **In the case of a failure or break in one of the links, the data takes an alternate path to the destination.**

# Demerits of Mesh Topology

- Mesh topology is generally too costly and complex for practical networks, and very hard to setup.
- Lots of cable required so that the installation cost is expensive.
- Network size is limited by the number of interconnections that can be made between the computers.
- It requires that the nodes of the network possess some type of logical 'routing'



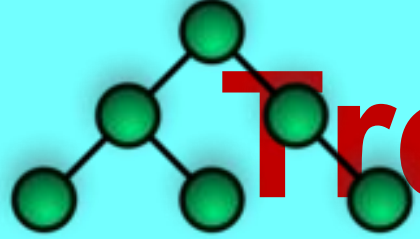

# Tree Topology

- Tree network topology is also known as a hierarchical network topology.
- This is because it contains

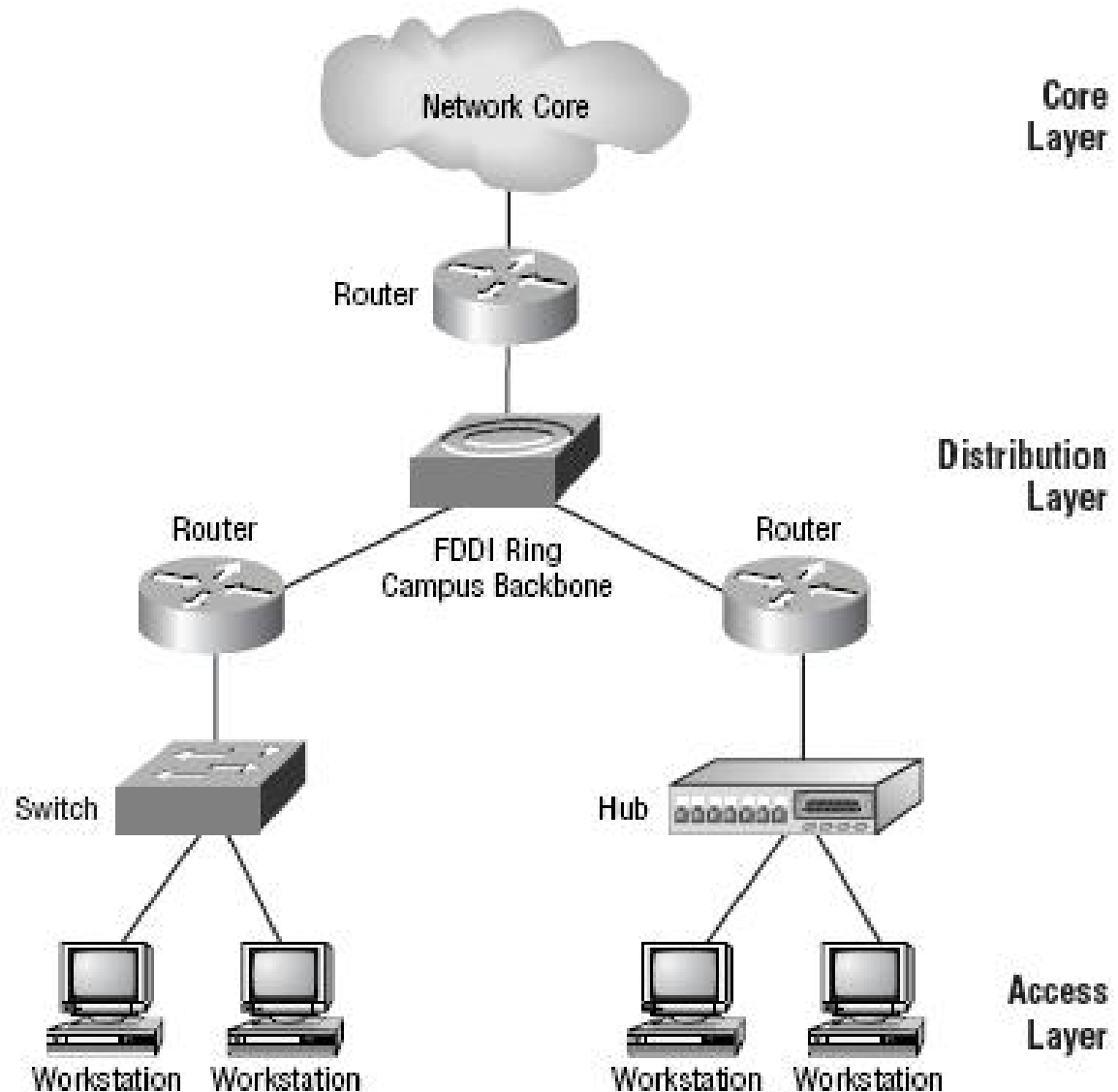

# Tree Topology

- The type of network topology in which a central 'root' node (the top level of the hierarchy) is connected to one or more other nodes that are one level lower in the hierarchy (i.e., the second level),
- Each of the second level nodes will also have one or more other nodes that are one level lower in the hierarchy (i.e., the third level) connected to it.
- The hierarchy of the tree is symmetrical - Each node in the network having a specific fixed number, of nodes connected to it at the next lower level in the hierarchy.
- It usually has three layers: the core layer, the

# Factors to consider When Choosing a Topology:

- **Cost.**
- **Future growth:**
- **Length of cable needed.**
- **Number of computers to be connected**
- **Level of security required**

**END OF UNIT**

**NEXT UNIT:  
702: Computer Networks**